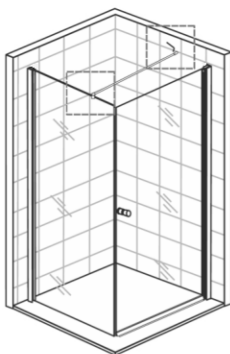
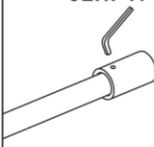
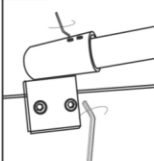
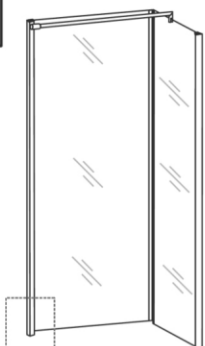
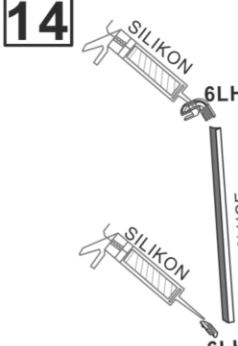
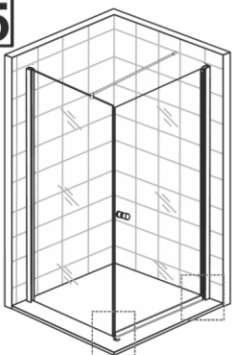
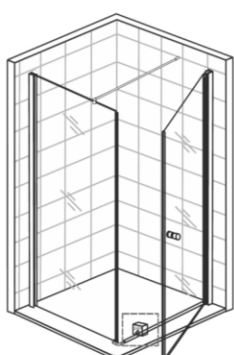
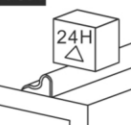
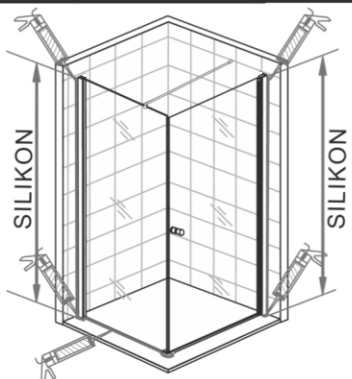
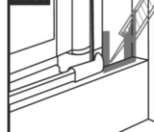
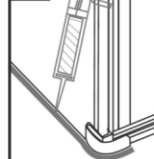

12**12.1** 6LHP17**12.2****13****14****SILIKON!****14.1**

6LHCE15

14.2

6LHCE12

15**15.1****15.2****16****16.1****17****17.1** SILIKON**17.2**

OSTROŻNIE! SZKŁO HARTOWANE!
 Szkło hartowane jest dużo bardziej odporne na zginanie i zmiany temperatur niż tradycyjne. Jest to szkło bezpieczne, gdyż po przekroczeniu jego wytrzymałości ulega rozbiciu na wiele drobnych kawałków, co minimalizuje ryzyko poważniejszego zranienia. Uszkodzona krawędź, zarysowanie powierzchni bądź zbyt silne napięcie (np. spowodowane nieprawidłowym montażem) może spowodować rozbicie szyby (popękanie). W zależności od wielkości ubytku lub siły naprężenia może to nastąpić bezpośrednio przy montażu bądź nawet po kilku miesiącach. Podczas montażu kabiny szczególnie należy dbać o to, aby krawędzie tafli szkła nie stykały się bezpośrednio z twardymi powierzchniami (np. nie należy opierać tafli szkła na kaflach - szczególnie narożników - podczas montażu). Krawędzie szkła powinny być zabezpieczone ochronnymi narożnikami lub ostonami z tworzywa sztucznego w trakcie wyjmowania z opakowania oraz montażu.

BK259T

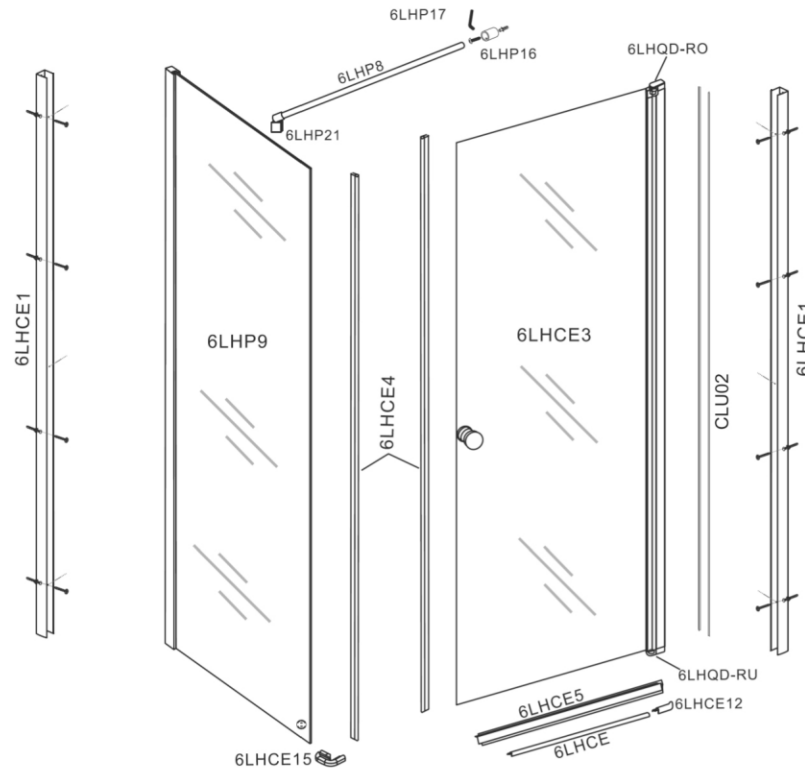

6CE14



1X

6LHP16

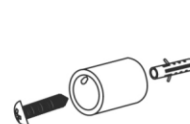

1X

6LHCE12

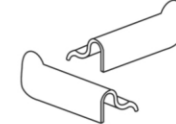

1X

6LHCE15

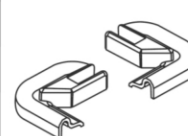

1X

6LHP21



1X

6CE

6CE8

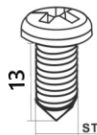

6X

6CE9

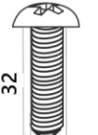

9X

6CE11



6LHP17



1X

6LHQD-RO

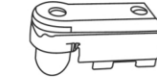

1X

6LHQD-RU

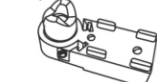

1X

