

**OSTROŻNIE! SZKŁO HARTOWANE!**

Szko hartowane jest duzo bardziej odporne na zginanie i zmiany temperatur niz tradycyjne. Jest to szklo bezpieczne, gdyz po przekroczeniu jego wytrzymałości ulega rozbiciu na wiele drobnych kawałków, co minimalizuje ryzyko poważniejszego zranienia. Uszkodzona krawędź, zarysowanie powierzchni bądź zbyt silne naprężenie ( np. spowodowane nieprawidłowym montażem) może spowodować rozbicie szyby (popękanie). W zależności od wielkości ubytku lub siły naprężenia może to nastąpić bezpośrednio przy montażu bądź nawet po kilku miesiącach. Podczas montażu kabiny szczególnie należy dbać o to, aby krawędzie tafli szkła nie stykały się bezpośrednio z twardymi powierzchniami (np. nie należy opierać tafli szkła na kafłach- szczególnie narożników - podczas montażu). Krawędzie szkła powinny być zabezpieczone ochronnymi narożnikami lub osłonami z tworzywa sztucznego w trakcie wyjmowania z opakowania oraz montażu.

BK260

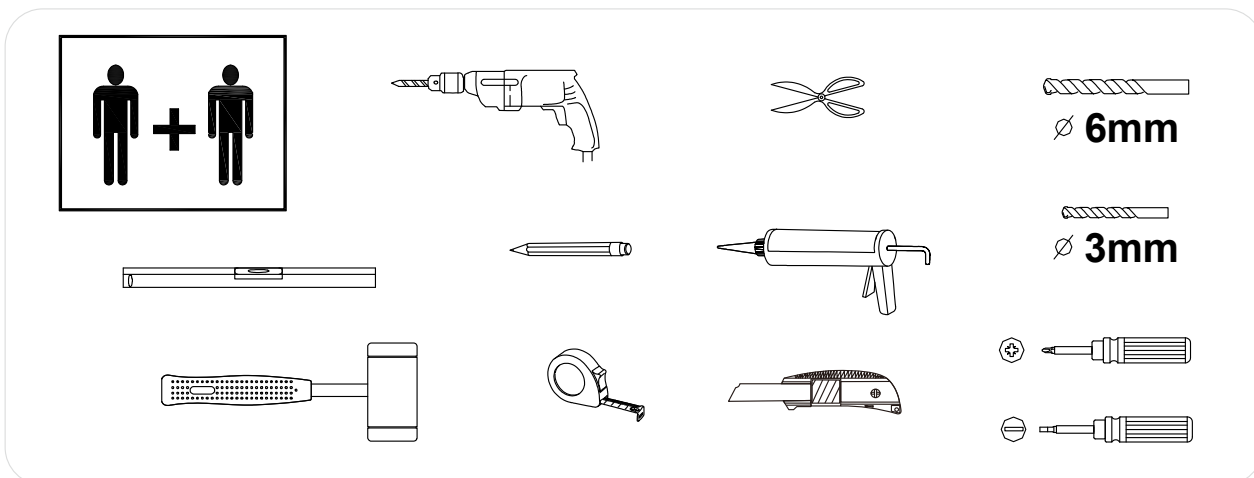

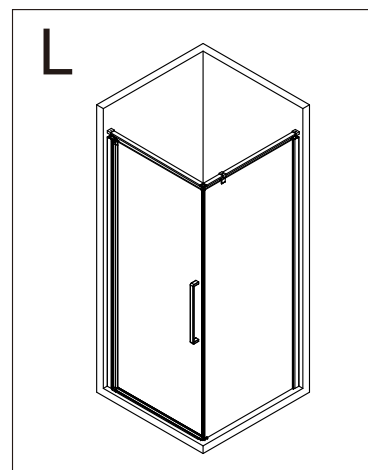
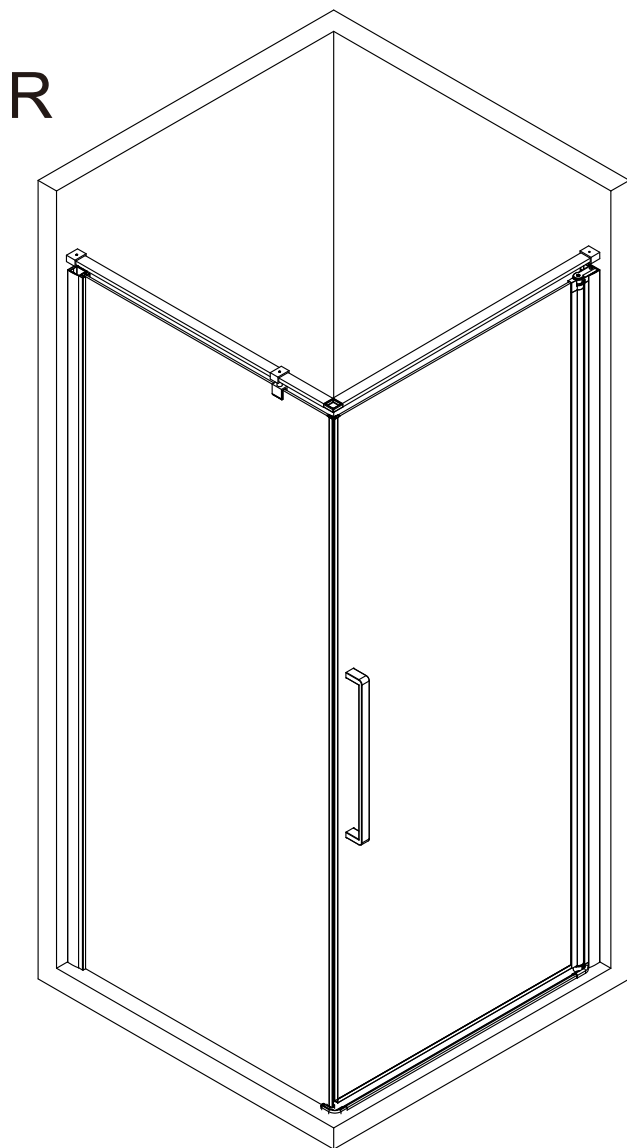
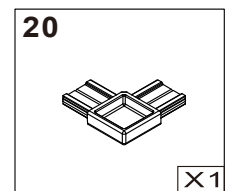
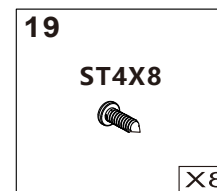
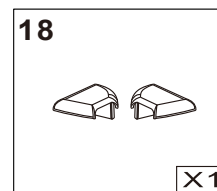
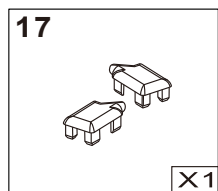
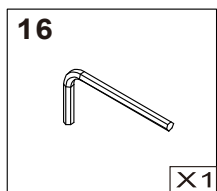
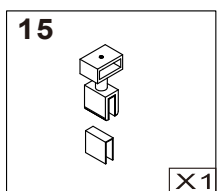
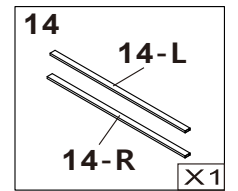
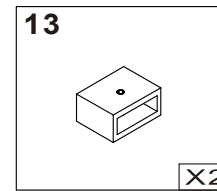
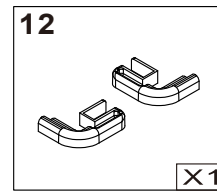
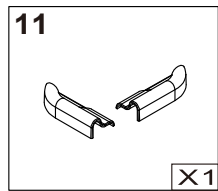
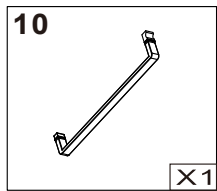
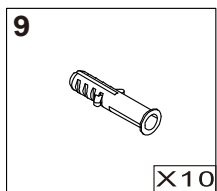
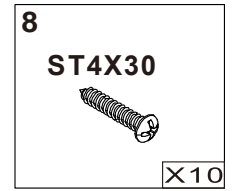
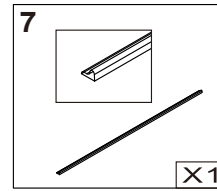
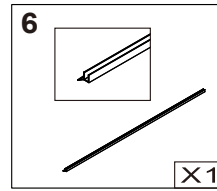
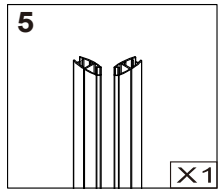
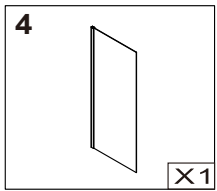
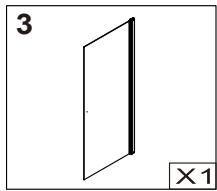
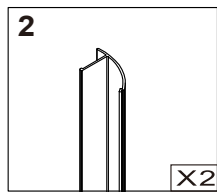
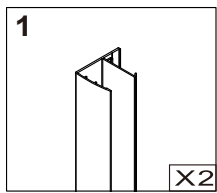
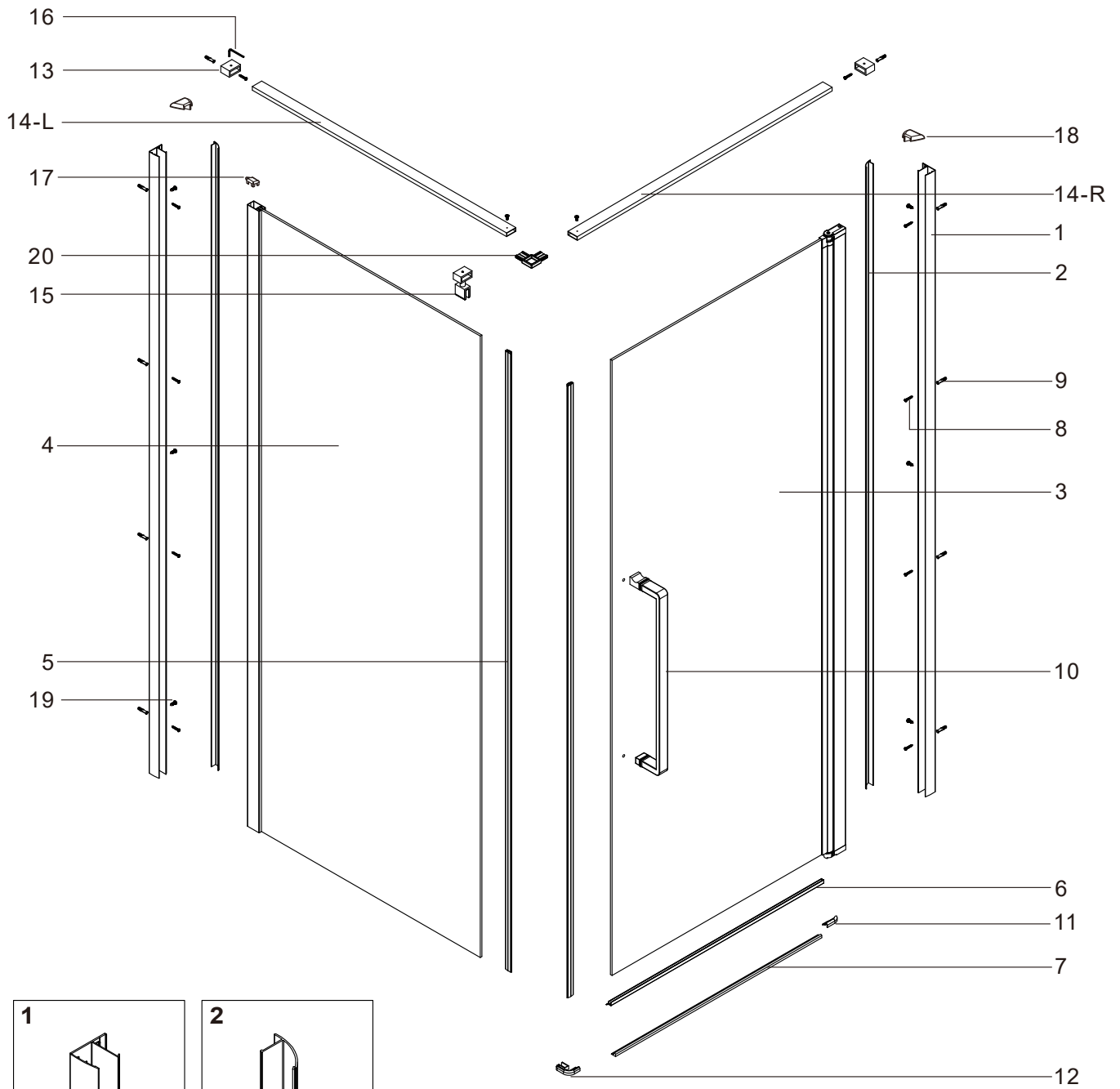

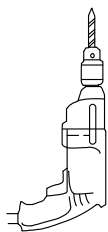
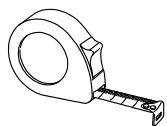

6mm

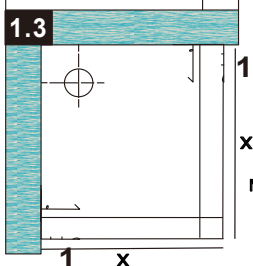
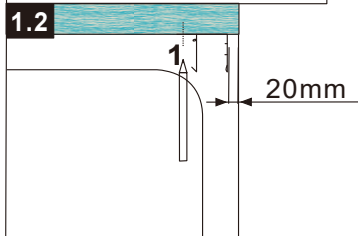
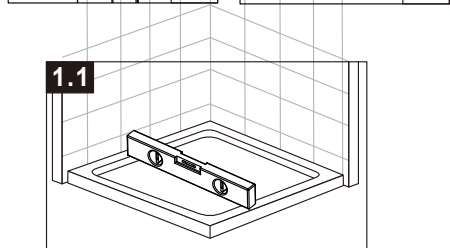
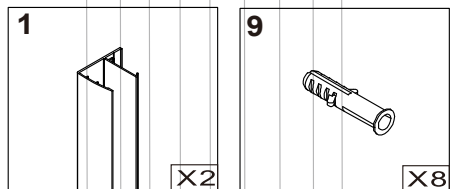
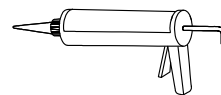
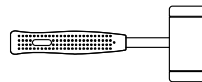

MODEL	WYMIAR X
80	780 mm
90	880 mm

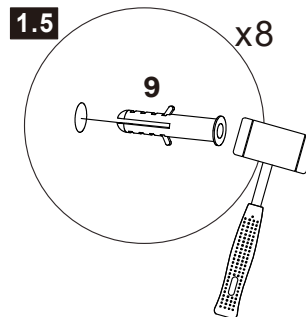
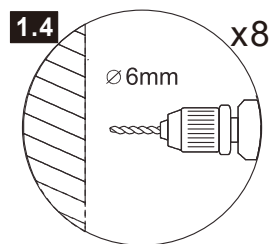
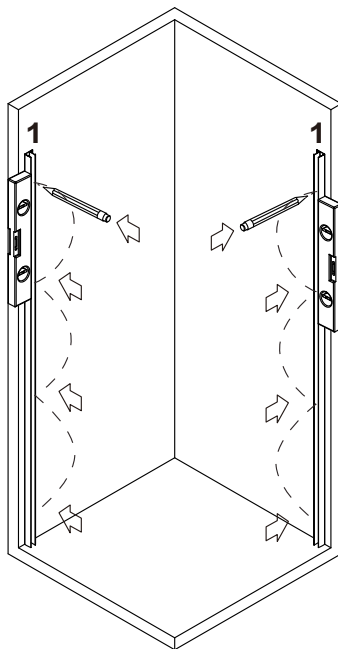

1

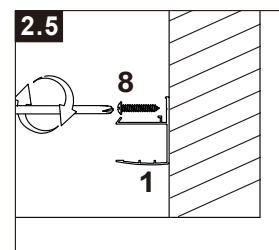
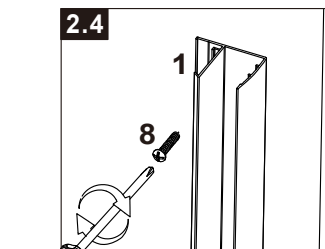
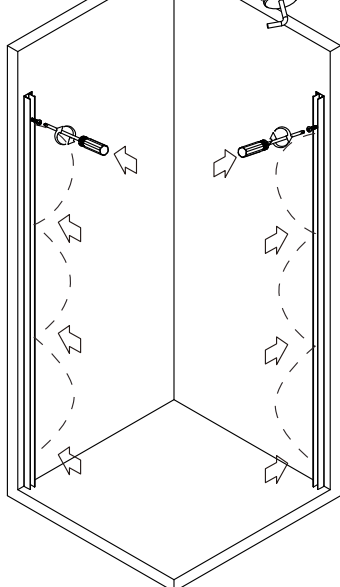
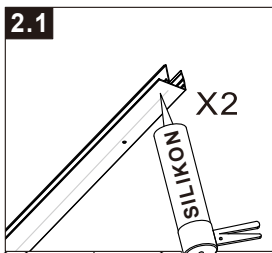
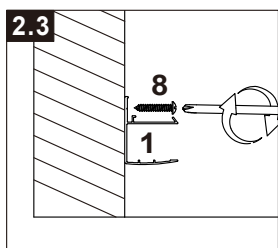
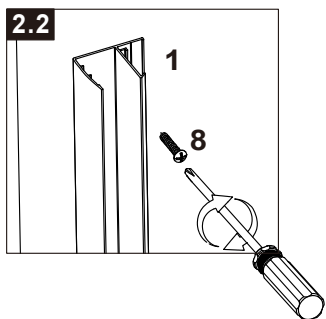
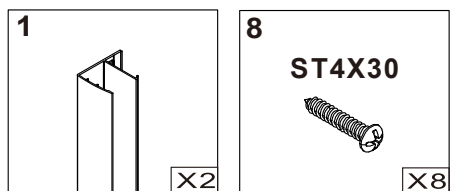

2

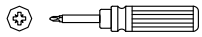
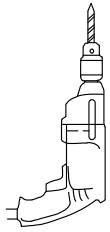

Ø 3mm

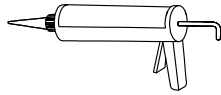

3

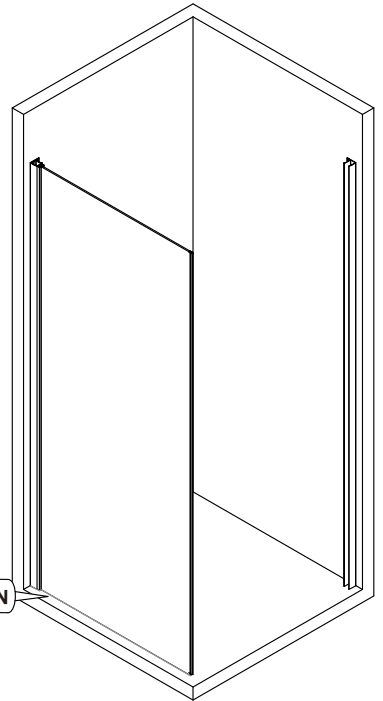
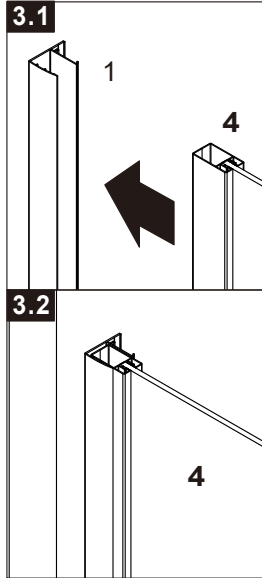
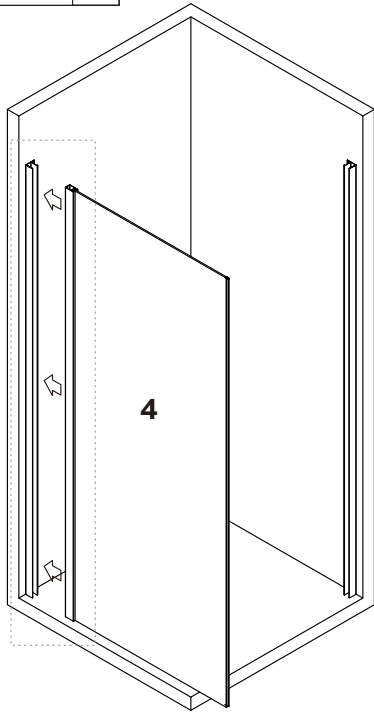
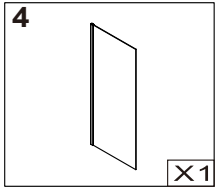

4

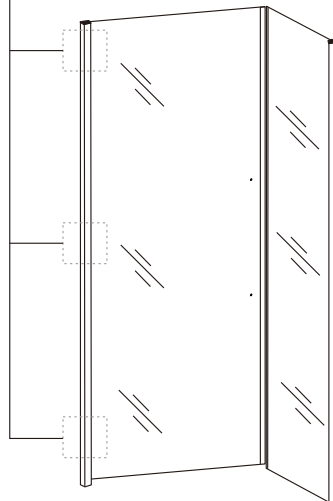
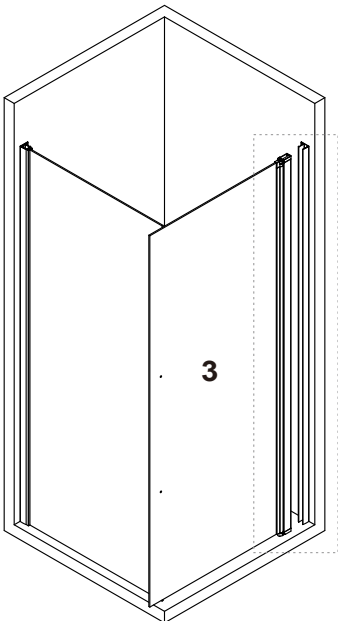
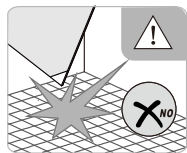
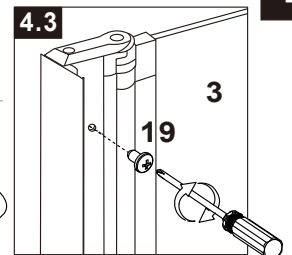
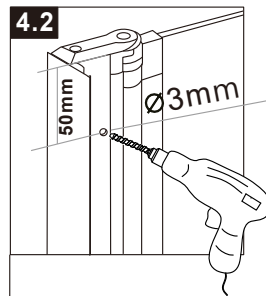
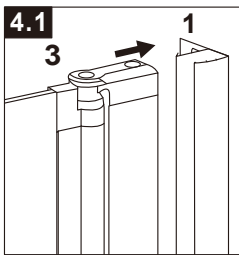
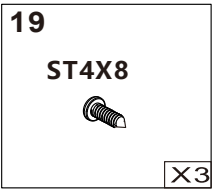
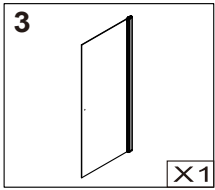

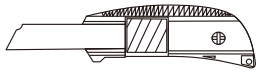

**5**

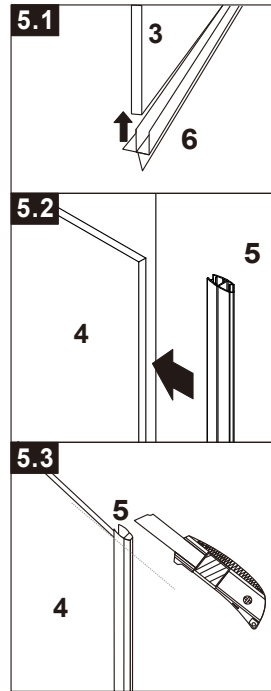
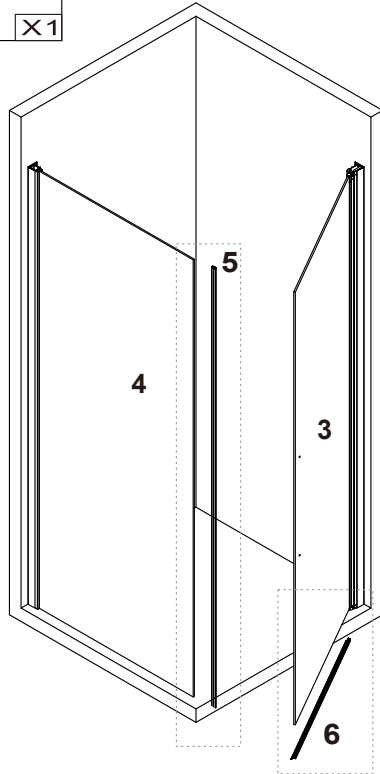
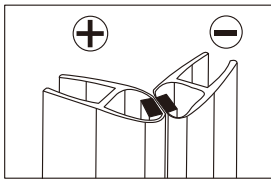
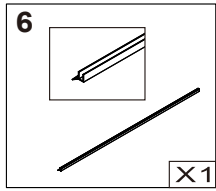
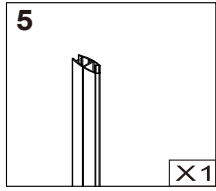

**6**

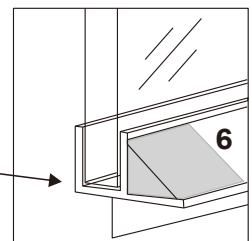
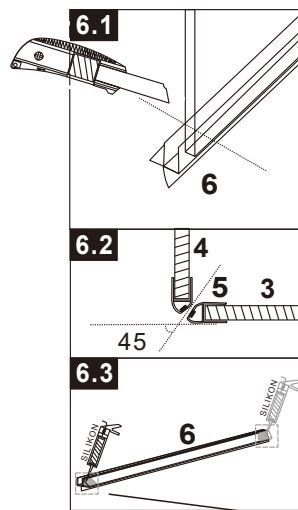
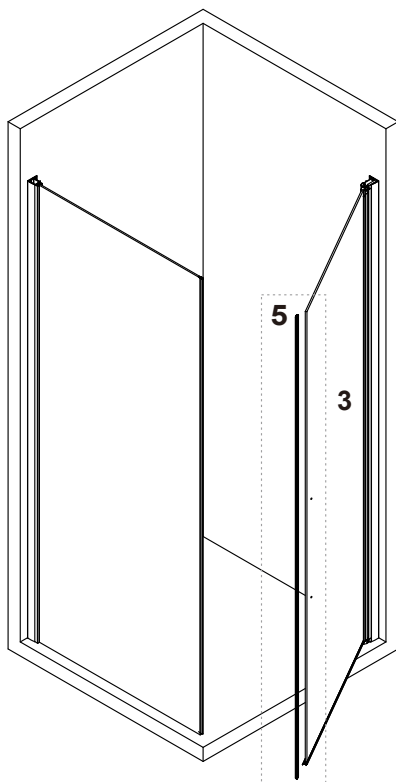
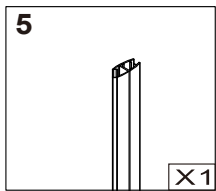

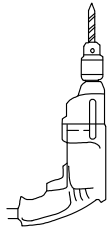
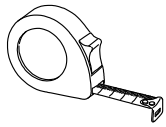
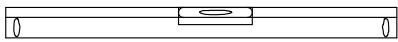

Ø 3mm

7

10

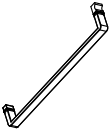

X1

19

ST4X8



X3

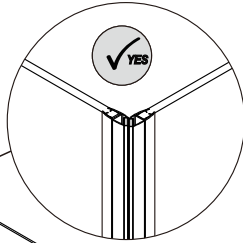

7.1

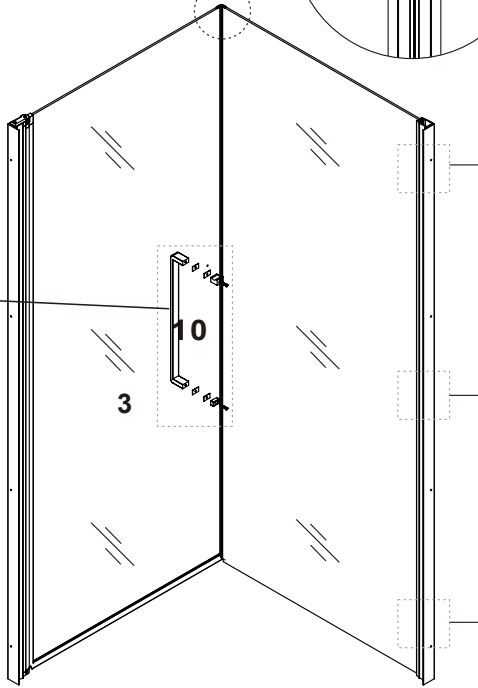
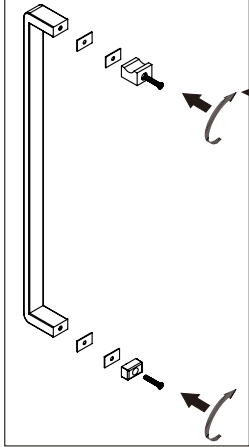

7.2

4

Ø3mm

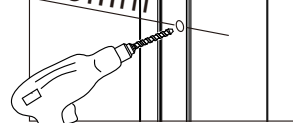

7.3

4

1

19

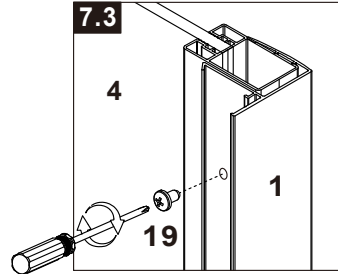

8

13



X2

14

14-L

14-R

X1

15



X1

20

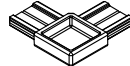

X1

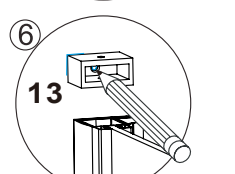
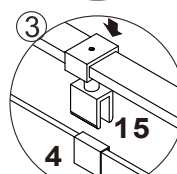
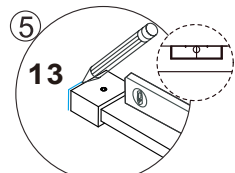
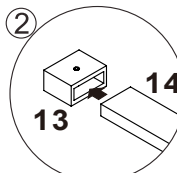
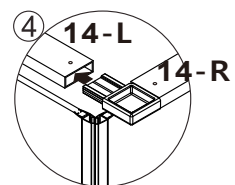
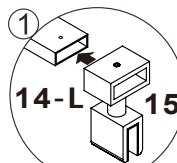
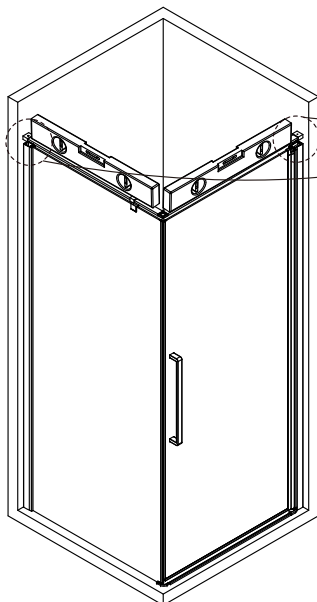

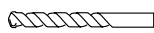
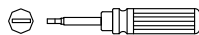
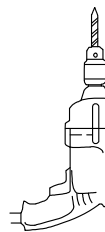
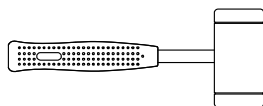
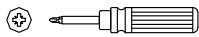

∅ 6mm

8

ST4X30



X2

9



X2

13



X2

9

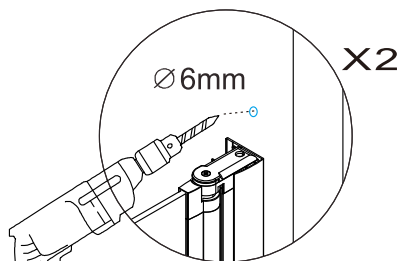
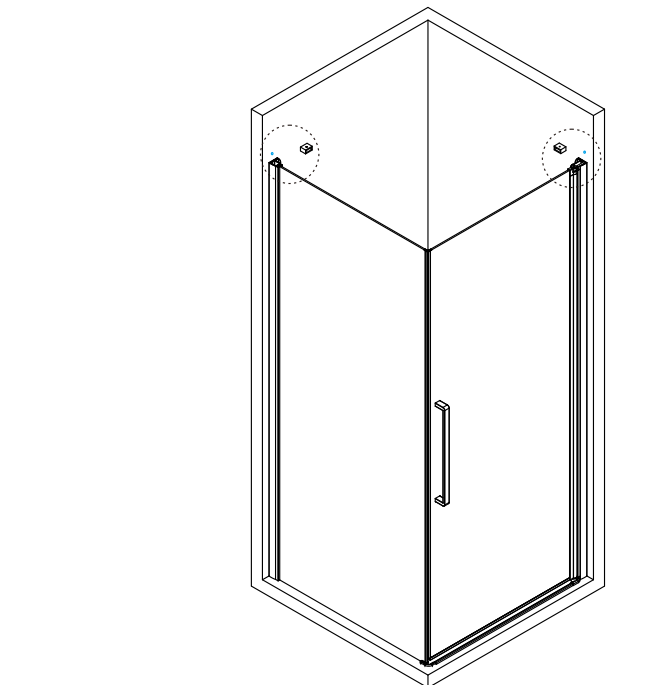

∅ 6mm

X2

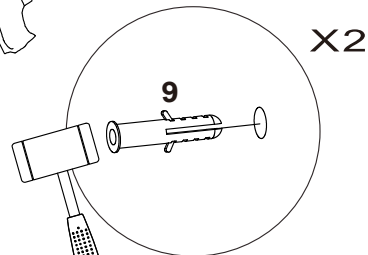

X2

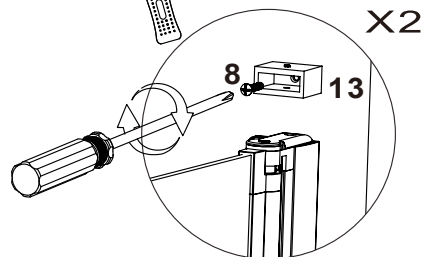

X2

14

14-L



14-R

X1

15

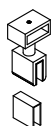

X1

16

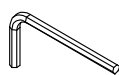

X1

19

ST4X8



X2

20

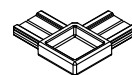

X1

10

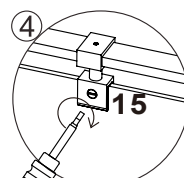
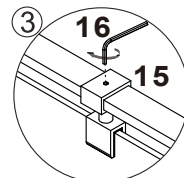
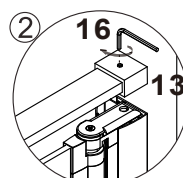
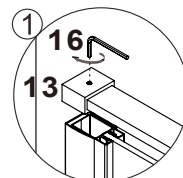
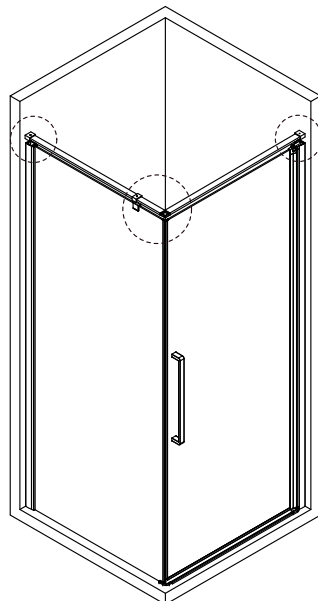
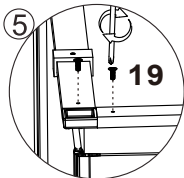
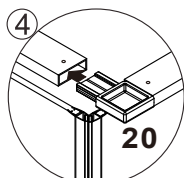
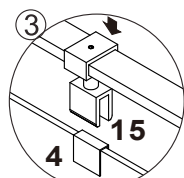
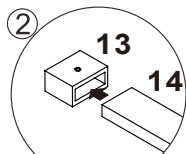
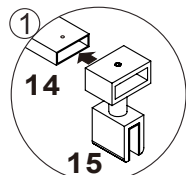

# 11

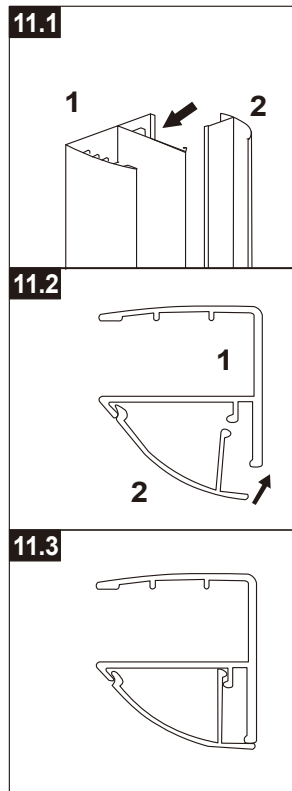
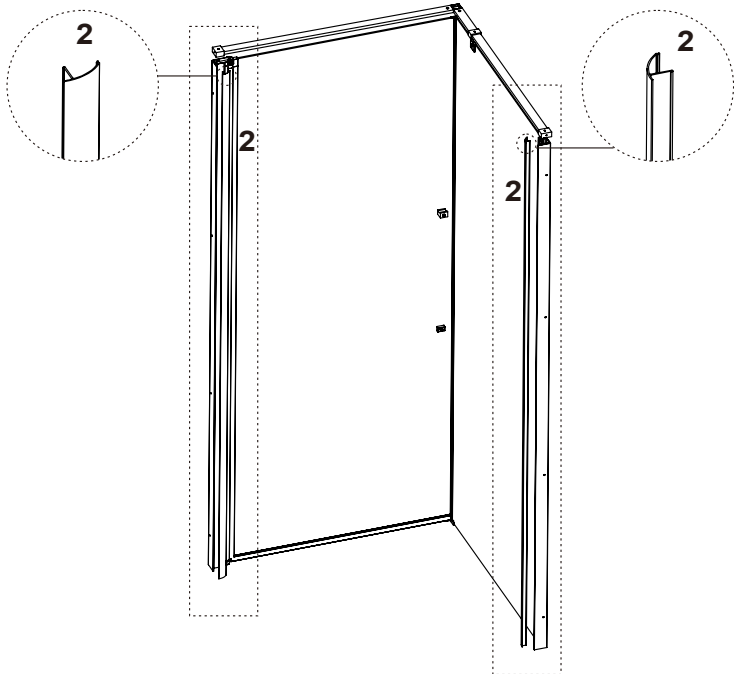
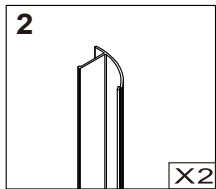

# 12

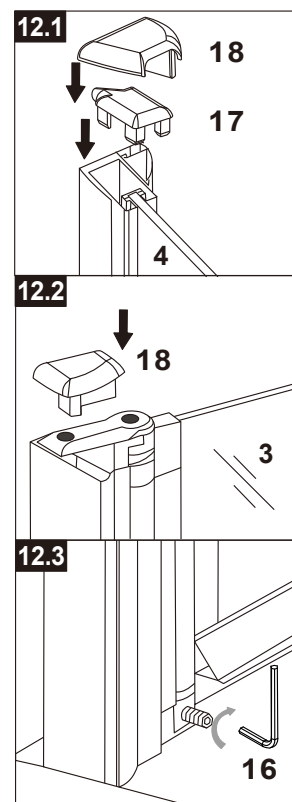
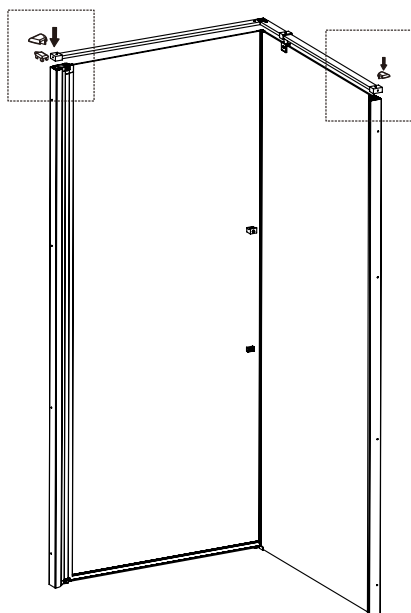
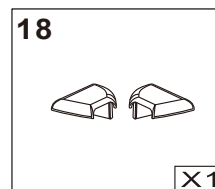
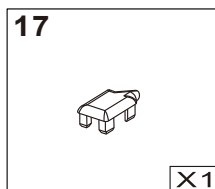
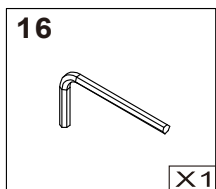



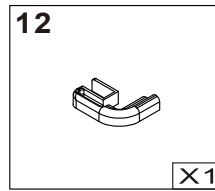
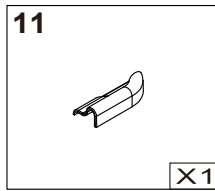
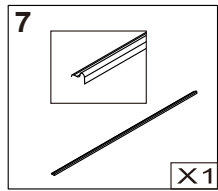
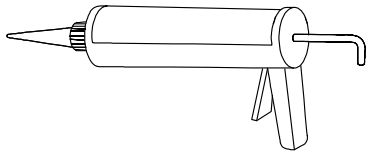

**13**

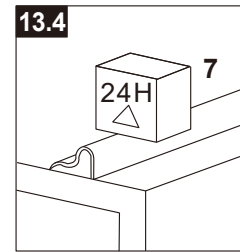
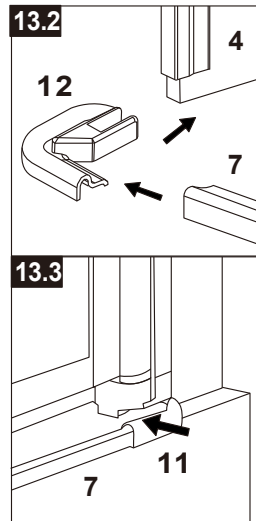
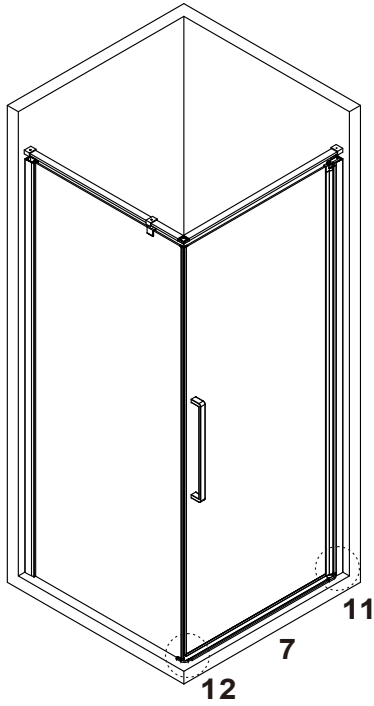
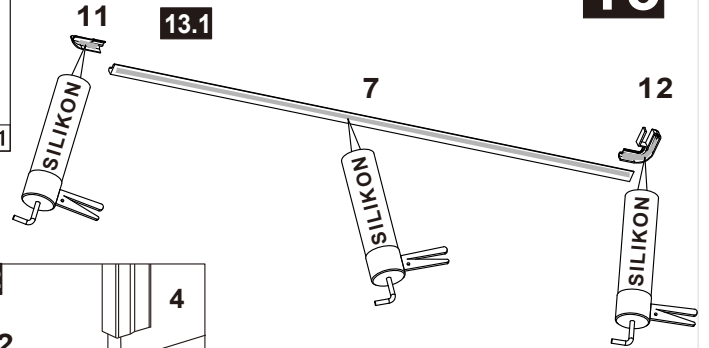

**14**

